

- **Power Rating of 4000 Watts**
- **100 BASE-TXI Twisted-Pair Wire, 100 BASE-FX Fiber, or LVDS (Low Voltage Differential Signaling)**
- **Supports Topologies - Line Type, Tree Type and Star Type**
- **Open Network Based on Ethernet**
- **Capable of Updating the Information of 1000 I/O**
- **Exchange of Frame as Big as 1486 Bytes**

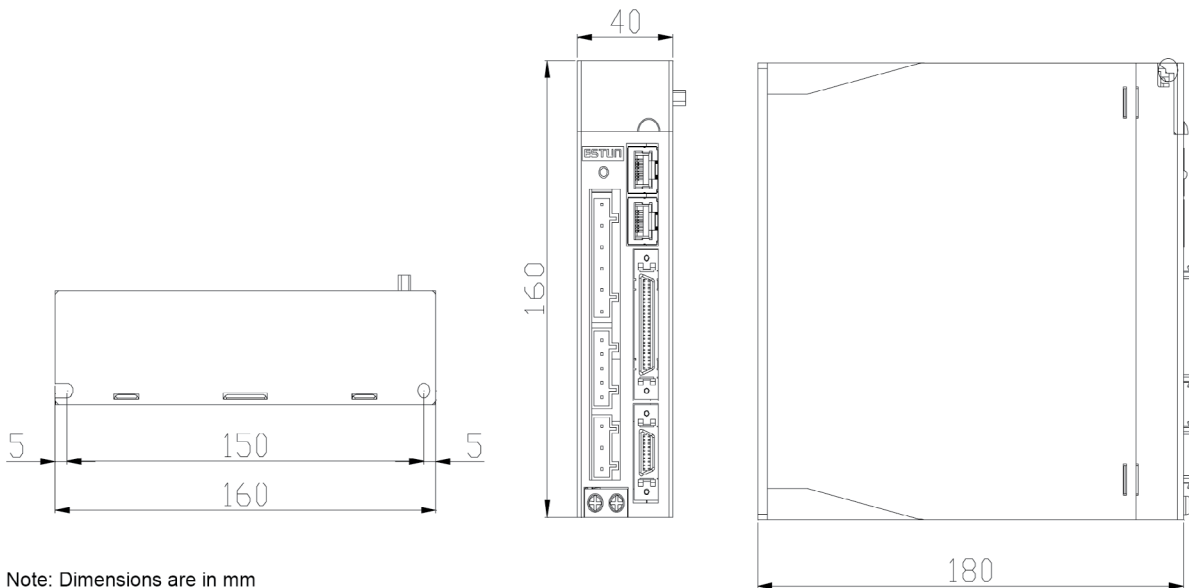

The EtherCAT is an open network based on Ethernet to achieve real time control. It is capable of supporting high speed and synchronized control. The efficient network topology allows the network structure with too many concentrator and complicated connections to be avoided. It's suited for protocol in motion control and factory automation applications. With the EtherCAT slave device it can read the data marked with the devices address information when the frame passes this device. Some data will be written into the when it passes this device. Because of this data reading and data writing could be done within several nanoseconds.



Item	Rated Power (Watts)	Rated Voltage	Drive Control Capabilities	COMM	I/O Signals
PRONET-40AEA-EC	4000	200VAC	Position, Speed, Torque	EtherCAT	5 Inputs 3 Outputs

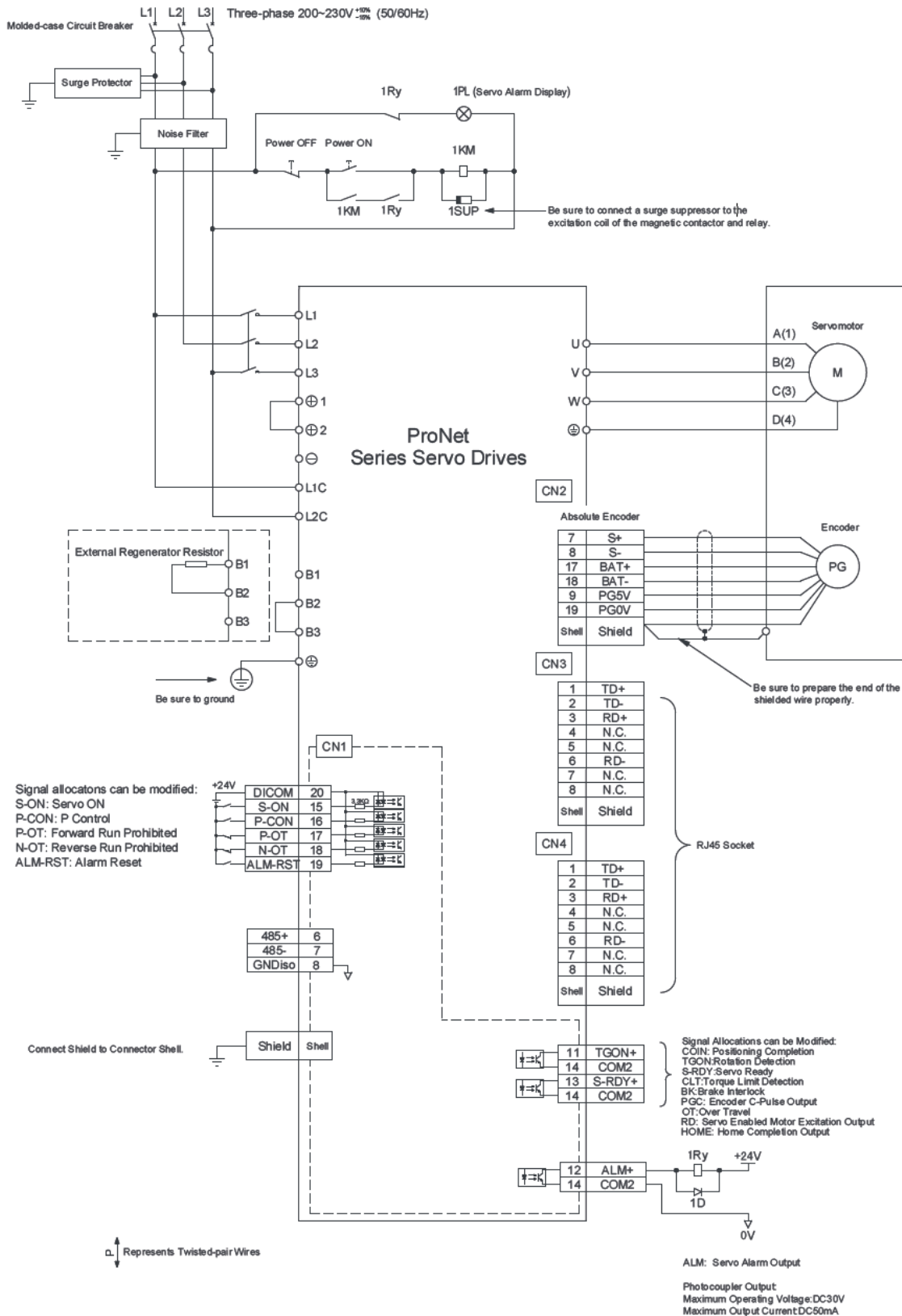

L011547